

| | | | | | |
|-------------|---|------------|------|---------------|--|
| | NAME | DATE | ENG. | JOCELYN R. L. | |
| DRAWN | J.R.L | 01/10/2019 | | | |
| CHECKED | J.R.L | 01/10/2019 | | | |
| ENG APPR. | J.R.L | 01/10/2019 | | | |
| MFG APPR. | | | | | |
| Q.A. | | | | | |
| MATERIAL | <div style="display: flex; align-items: center;"> <div style="border: 1px solid black; padding: 5px; margin-right: 10px;"> ABS Black Grey Wood Grain </div> <div style="text-align: right;">  </div> </div> | | | | |
| SIZE | DWG. NO. | | | REV | |
| A | BINENDCAP-381332 | | | | |
| SCALE: 1:12 | | WEIGHT: | | SHEET 1 OF 1 | |

PROPRIETARY AND CONFIDENTIAL

THE INFORMATION CONTAINED IN THIS DRAWING IS THE SOLE PROPERTY OF BORRAY PLASTICS MFG INC. ANY REPRODUCTION IN PART OR AS A WHOLE WITHOUT THE WRITTEN PERMISSION OF BORRAY PLASTICS MFG INC IS PROHIBITED.

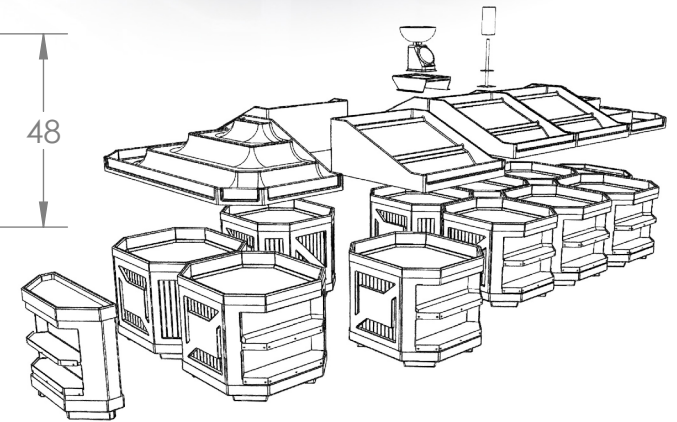
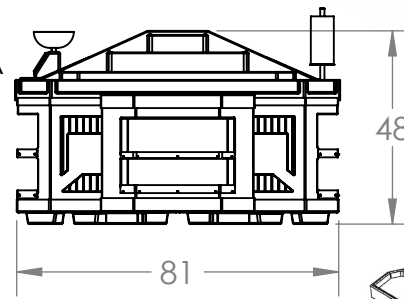
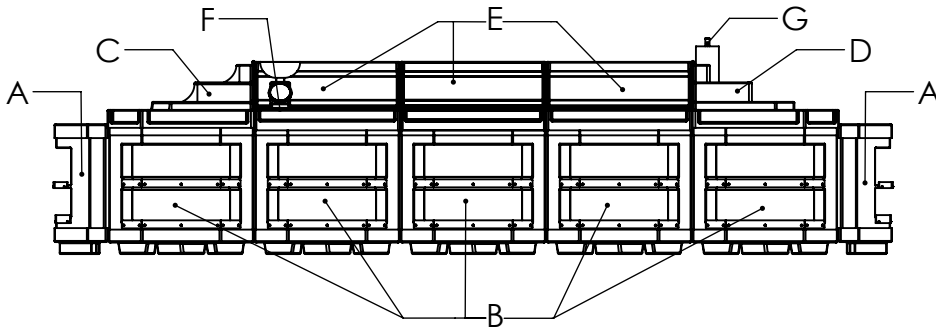
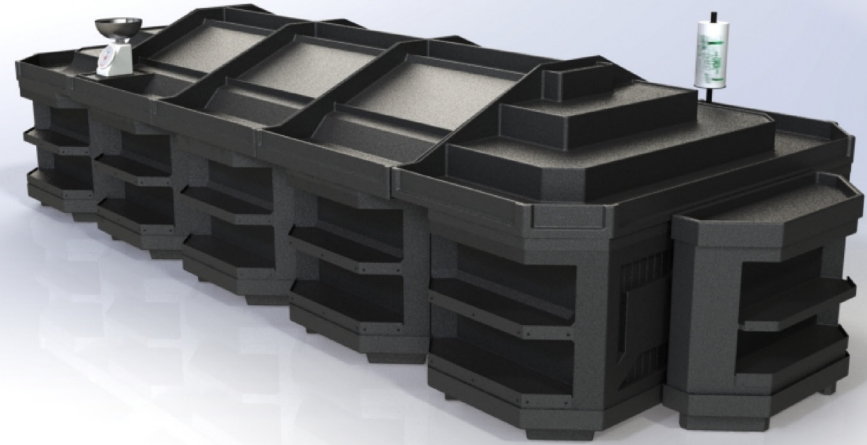
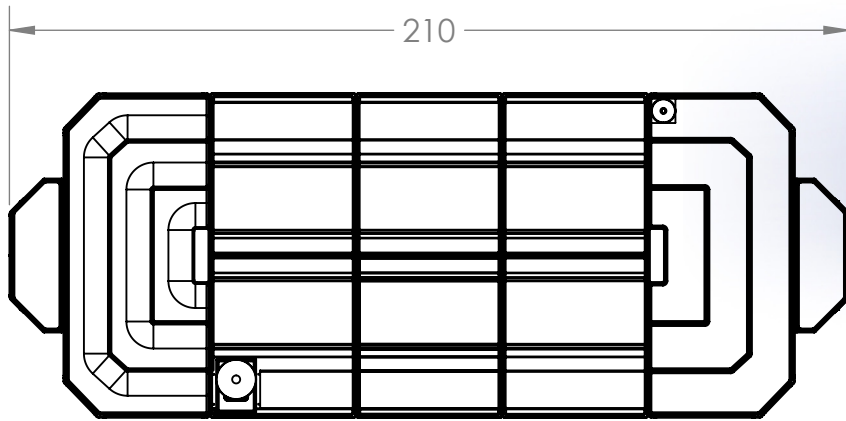

| | Item #: | Quantity: |
|---|-------------------|-----------|
| A | BINENDCAP-381332 | 2 |
| B | BOXCOM-3640 | 10 |
| C | BANANA-2BC3640 | 1 |
| D | STEPRISER-2BC3640 | 1 |
| E | ERISER-BC3640 | 6 |
| F | SCALEH-BC3640 | 1 |
| G | VTRA-129 | 1 |

PROPRIETARY AND CONFIDENTIAL

THE INFORMATION CONTAINED IN THIS DRAWING IS THE SOLE PROPERTY OF BORRAY MFG INC. ANY REPRODUCTION IN PART OR AS A WHOLE WITHOUT THE WRITTEN PERMISSION OF BORRAY MFG INC IS PROHIBITED.

| | NAME | DATE | ENG. | JOCELYN R. C. |
|-----------|---------|------------|------|---------------|
| DRAWN | J.R.C. | 03/18/2021 | | |
| CHECKED | | | | |
| ENG APPR. | | | | |
| MFG APPR. | | | | |
| Q.A. | | | | |
| MATERIAL | Blk ABS | | | |

| | | | | |
|-------------|---------|--------------|-------------------------------|-----|
| | | SIZE | DWG. NO. | REV |
| | | A | BOXCOM-3640 Produce Island | |
| SCALE: 1:48 | WEIGHT: | SHEET 1 OF 1 | | |



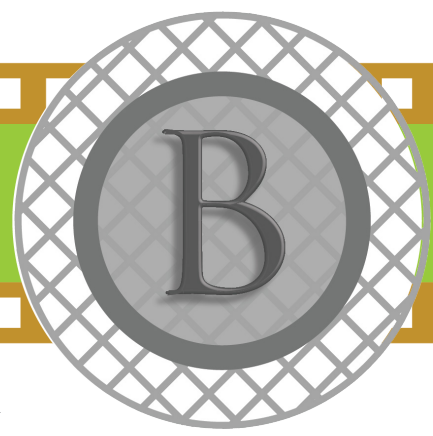

ABS Materials

for all BOXCUM, BOXCOMSH, BINENDCAP, MPB, SQRB, BINBT, BINB Sleeves

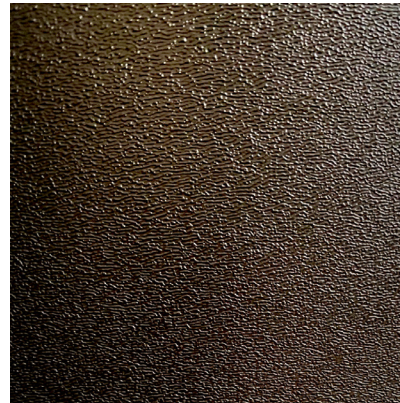

Black Textured
Add "BLK" to item number



Weave
Add "WE" to item number



Gray Woodgrain
Add "GRAY" to item number

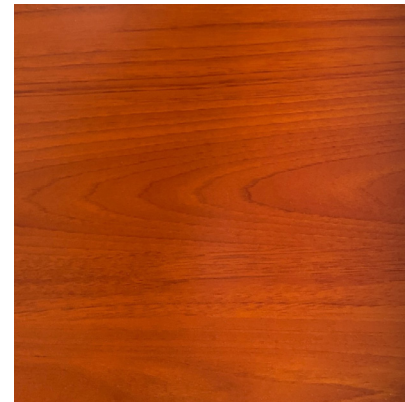

Yorkshire Cherry
Add "YSC" to item number

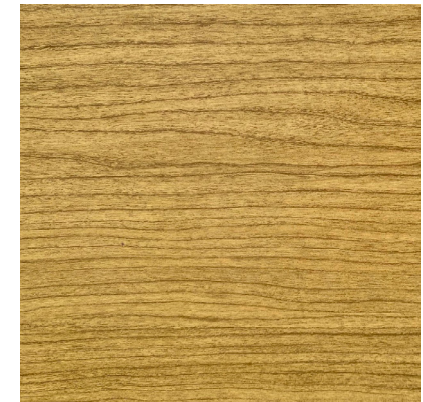

Bamboo
Add "BB" to item number